

5MP LightHunter HD IR Fixed Turret Analog Camera

UAC-T125-AF28(40)LM



Introduction

UAC-T125-AF28(40)LM is a 5MP LightHunter HD IR fixed turret analog camera with a high-performance 1/2.7-inch CMOS sensor. It supports TVI/AHD/CVI/CVBS, which effectively enhances product adaptability and diversity of networking solutions. With SYV-75-3 or other coaxial cable types, the camera can achieve low-cost, long-distance, and anti-interference mega-pixel HD video transmission without time delay. It supports IR-cut filter with auto-switch (ICR) and provides color images at daytime and black/white images at night. The camera also supports audio input and synchronous transmission of audio and video.

Features

- High quality imaging with 5MP resolution
- TVI/AHD/CVI/CVBS
- Supports IR-cut filter with auto-switch (ICR)
- LightHunter monitoring with high-sensitivity sensor
- Supports 180° horizontal flip, 180° vertical flip
- OSD configuration menu, easy to operate
- IP67 waterproof and dustproof design, high reliability
- OSD configuration menu in 11 languages
- Built-in microphone for high quality audio transmission via coaxial cables
- 3-Axis

Specifications

Model	UAC-T125-AF28LM	UAC-T125-AF40LM
Sensor		
Pixel	5MP	
Size	1/2.7"	
Minimum illumination	0.005 lux (F1.6, AGC ON) 0 lux (IR on)	
Lens		
Lens	2.8mm	4.0mm
Lens mount	M12	
Angle of view	H: 109.1° V: 60.9° D: 126.7°	H: 91.3° V: 46.1° D: 109.6°
Illuminator		
Illuminator	Two IR illuminators	
Illumination distance	40m	
Lifetime	≥60,000 hours	
Video		
Resolution	5MP@25fps: 2880(H)×1620(V); 5MP@20fps: 2592(H)×1944(V); 5MP@12.5fps: 2592(H)×1944(V) 4MP: 2560(H)×1440(V) 1080P: 1920(H)×1080(V)	
Frame rate	TVI: 5MP@20fps (default), 5MP@12.5fps, 4MP@30fps, 4MP@25fps, 1080P@30fps, 1080P@25fps AHD: 5MP@20fps, 4MP@30fps, 4MP@25fps, 1080P@30fps, 1080P@25fps CVI: 5MP@25fps, 4MP@30fps, 4MP@25fps, 1080P@30fps, 1080P@25fps CVBS: PAL, NTSC	
Shutter time	PAL: 1/25s-1/50000s NTSC: 1/30s-1/50000s	
Image		
Exposure mode	Four modes: Global (default), BLC, HLC, DWDR	
Day/Night	Three modes: Auto (default), Day, Night	
Digital noise reduction	2D	
White balance	Two modes: Auto (default), Manual	
WDR	DWDR	
Smart IR	Support	
Flip	Supports 180° horizontal flip, 180° vertical flip	
Audio		
Microphone	Built-in Mic	
Camera audio	TVI: 5MP@20fps, 5MP@12.5fps, 4MP@30fps, 4MP@25fps, 1080P@30fps, 1080P@25fps CVI: 5MP@25fps, 4MP@30fps, 4MP@25fps	
Interface		
Power	5.5mm power interface	
Video output	BNC, supports TVI/AHD/CVI/CVBS	
Operating environment		
Temperature	-30°C to 60°C (-22°F to 140°F)	
Humidity	≤95% (RH, non-condensing)	
Surge protection	4kV	

Ingress protection	IP67
General	
Power	DC 12V (±25%), with reverse polarity protection, Max 3.4W
Mount	Surface mount (default), optional backbox, wall mount bracket
Dimensions	Φ111mm*98mm (diameter*height)
Material	Metal+Plastic
Weight	334g (0.74lb)
Certification	CE, FCC, UL

Dimensions

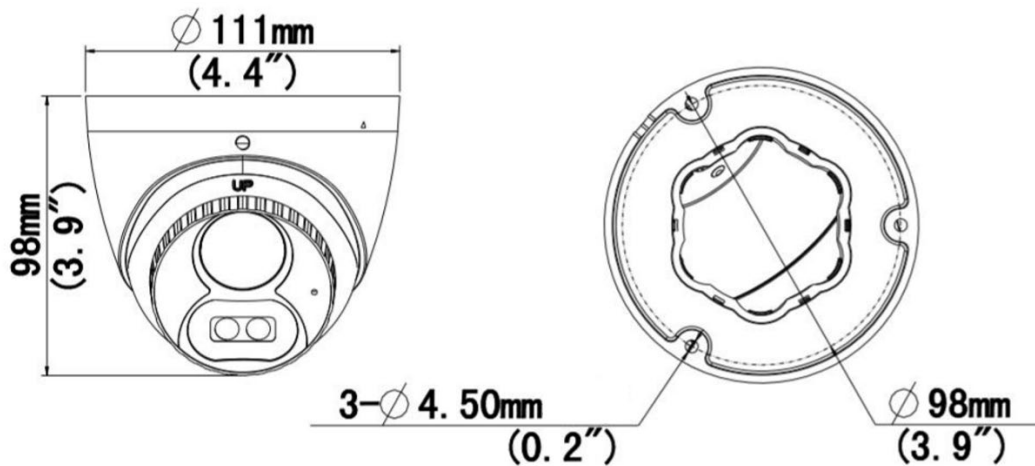

UAC-T125-AF28(40)LM

Accessories

TR-JB03-G-IN

Junction Box



TR-JB07/WM03-G-IN

Wall Mount



TR-WM03-D-IN

Wall Mount

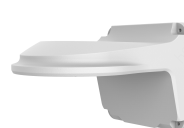

TR-A01-IN

Waterproof joint



TR-UP06-IN

Pole Mount

TR-UC08-C

Corner mount

TR-SE24-A-IN

Pendant Mount

TR-CM24-IN

Pendant Mount



TR-SE24-IN

Pendant Mount

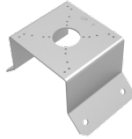

PWR-DC1201A-UK

Wall Plug-in UK Power Adapter



PWR-DC1201A-US

Wall Plug-in US Power Adapter



PWR-DC1201A-EU

Wall Plug-in EU Power Adapter



Mount

TR-JB03-G-IN

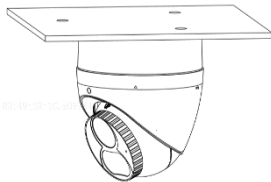

TR-JB07/WM03-G-IN(TR-WM03-D-IN)

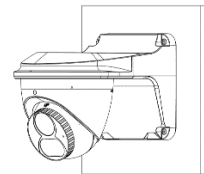

TR-JB07/WM03-G-IN(TR-WM03-D-IN)+TR-UP06-IN

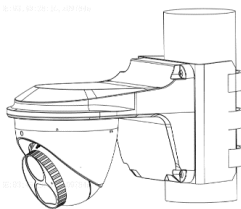

TR-JB07/WM03-G-IN(TR-WM03-D-IN)+TR-UC08-C

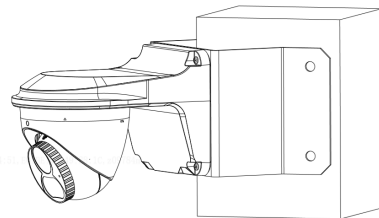

TR-CM24-IN+TR-JB03-G-IN

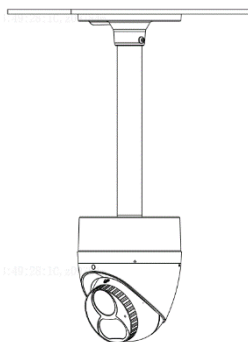

Zhejiang Uniview Technologies Co., Ltd.

Building No.10, Wanlun Science Park, Jiangling Road 88, Binjiang District, Hangzhou, Zhejiang, China (310051)

Email: overseasbusiness@uniview.com; globalsupport@uniview.com

<https://www.uniview.com>

©2023 Zhejiang Uniview Technologies Co., Ltd. All rights reserved.

*Product specifications and availability are subject to change without notice.